



X1 Series User Manual

2.5kw - 3.3kw



EN



Solax Power Co., Ltd.

No.288 Shizhu Road, Tonglu Economic Development Zone,
Tonglu City, Zhejiang Province, China.

Tel: +86 0571-56260011

E-mail: info@solaxpower.com

Copy Declaration

The copyright of this manual belongs to SolaX Power Co.,Ltd.. Any corporation or individual should not plagiarize, partially or fully copy(including software,etc.), and no reproduction or distribution of it in any form or by any means. All rights reserved. SolaX Power Co.,Ltd.,reserves the right of final interpretation.

Contents

1 NOTES ON THIS MANUAL	01
1.1 SCOPE OF VALIDITY	01
1.2 TARGET GROUP	01
1.3 SYMBOLS USED	01
2 SAFETY	02
2.1 APPROPRIATE USAGE	02
2.2 IMPORTANT SAFETY INSTRUCTIONS	04
2.3 PE CONNECTION AND LEAKAGE CURRENT	06
2.4 EXPLANATION OF SYMBOLS	07
3 INTRODUCTION	08
3.1 BASIC FEATURES	08
3.2 TERMINALS OF PV INVERTER	08
3.3 DIMENSION AND WEIGHT	09
4 TECHNICAL DATA	10
4.1 DC INPUT	10
4.2 AC OUTPUT	10
4.3 EFFICIENCY, SAFETY AND PROTECTION	11
4.4 GENERAL DATA	11
5 FUNCTION	12
5.1 CHECK FOR TRANSPORTATION DAMAGE	12
5.2 PACKING LIST	12
5.3 INSTALLATION PRECAUTION	13
5.4 INSTALLATION STEPS	14
5.5 CONNECTION OF THE Inverter	15
5.6 START THE INVERTER	23
6 OPERATION METHOD	24
6.1 INDICATOR PANEL	24
6.2 INDICATOR INFORMATION	24
7 TROUBLESHOOTING	27
7.1 TROUBLESHOOTING	27
7.2 MAINTENANCE	29

8 DECOMMISSIONING	30
8.1 DECOMMISSIONING	30
8.2 STORAGE AND TRANSPORTATION	30
8.3 DISPOSAL	30

1 Notes on this Manual

1.1 Scope of validity

This installation guide describes the assembly, installation, commissioning, maintenance and failure search of the following series inverter.

X1-2.5-S-D	X1-3.0-S-D	X1-3.3-S-D
X1-2.5-S-N	X1-3.0-S-N	X1-3.3-S-N

Note: **"2.5"** means 2.5kW. **"S"** means "single" or one MPPT string. **"D"** means with "DC Switch", **"N"** means without "DC Switch".

Please store this manual where it will be accessible at all times.

1.2 Target Group

This manual is for qualified personnel. The tasks described in this manual may only be performed by qualified personnel.

1.3 Symbols Used

The following types of safety instructions and general information appear in this document described as below.



Danger!

Danger indicates a hazardous situation which, if not avoided, will result in death or serious injury.



Warning!

Warning indicates a hazardous situation which, if not avoided, could result in death or serious injury.



Caution!

Caution indicates a hazardous situation which, if not avoided, could result in death or serious injury.



Note!

Note provides tips that are valuable for the optimal operation of your product.

2. Safety

2.1 Appropriate Usage

The X1 series are PV inverters which convert the DC current of a PV generation into AC current and feeds it into the public grid.

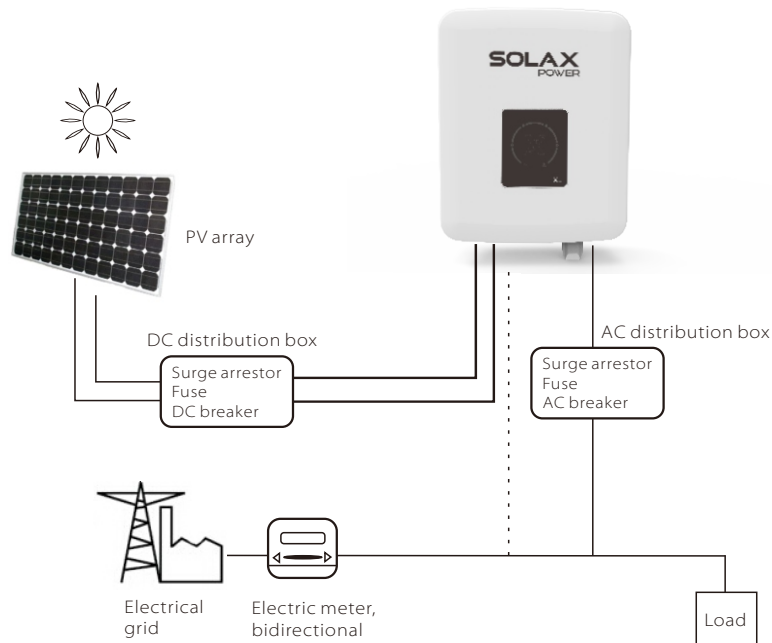

CAUTION !

For X1-1.1-S-N, X1-1.5-S-N, X1-2.0-S-N, external dc breaker must be connected on the PV side.

► Surge protection devices (SPDs) for PV installation



WARNING !

Over-voltage protection with surge arresters should be provided when the PV power system is installed. The grid connected inverter is not fitted with SPDs in both PV input side and MAINS side.

Lightning will cause a damage either from a direct strike or from surges due to a nearby strike.

Induced surges are the most likely cause of lightning damage in majority of installations, especially in rural areas where electricity is usually provided by long overhead lines. Surge may be included on both the PV array conduction and the AC cables leading to the building.

Specialists in lightning protection should be consulted during the end use application. Using appropriate external lightning protection, the effect of a direct lightning strike into a building can be mitigated in a controlled way, and the lightning current can be discharged into the ground.

Installation of SPDs to protect the inverter against mechanical damage and excessive stress include a surge arrester in case of a building with external lightning protection system (LPS) when separation distance is kept.

To protect the DC system, surge suppression device (SPD type2) should be fitted at the inverter end of the DC cabling and at the array located between the inverter and the PV generator, if the voltage protection level (VP) of the surge arresters is greater than 1100V, an additional SPD type 3 required for surge protection for electrical devices.

To protect the AC system, surge suppression devices (SPD type2) should be fitted at the main incoming point of AC supply (at the consumer's cutout), located between the inverter and the meter/distribution system; SPD (test impulse D1) for signal line according to EN 61632-1.

All DC cables should be installed to provide as short a run as possible, and positive and negative cables of the string or main DC supply should be bundled together. Avoiding the creation of loops in the system. This requirement for short runs and bundling includes any associated earth bundling conductors.

Spark gap devices are not suitable to be used in DC circuits once conducting, they won't stop conducting until the voltage across their terminals is typically more than 30 volts.

2.2 Important Safety Instructions

 **Danger!**
Danger to life due to high voltages in the inverter!

- All work must be carried out by qualified electrician.
- The appliance is not to be used by children or persons with reduced physical sensory or mental capabilities, or lack of experience and knowledge, unless they have been given supervision or instruction.
- Children should be supervised to ensure that they do not play with the appliance.

 **Caution!**
Danger of burn injuries due to hot enclosure parts!

- During operation, the upper lid of the enclosure and the enclosure body may become hot.
- Only touch the lower enclosure lid during operation.

 **Caution!**
Possible damage to health as a result of the effects of radiation!

- Do not stay closer than 20 cm to inverter for any length of time.

 **Note!**
Grounding the PV generator.

- Comply with the local requirements for grounding the PV modules and the PV generator. SolaX recommends connecting the generator frame and other electrically conductive surfaces in a manner which ensures continuous conduction and ground these in order to have optimal protection of system and persons.

 **Warning!**

- Ensure input DC voltage \leq Max. DC voltage. Over voltage may cause permanent damage to inverter or other losses, which will not be included in warranty!

 **Warning!**

- Authorized service personnel must disconnect both AC and DC power from X1-boost before attempting any maintenance or cleaning or working on any circuits connected to the X1-boost.

 **Warning !**
 Do not operate the inverter when the device is running.

 **Warning !**
 Risk of electric shock!

- Prior to the application, please read this section carefully to ensure correct and safe application. Please keep the user manual properly.
- Use only attachments recommended or sold by SolaX. Otherwise may result in a risk of fire, electric shock, or injury to person.
- Make sure that existing wiring is in good condition and that wire is not undersized.
- Do not disassemble any parts of inverter which are not mentioned in installation guide. It contains no user-serviceable parts. See Warranty for instructions on obtaining service. Attempting to service the X1-boost Series inverter yourself may result in a risk of electric shock or fire and will void your warranty.
- Keep away from flammable, explosive materials to avoid fire disaster.
- The installation place should be away from humid or corrosive substance.
- Authorized service personnel must use insulated tools when installing or working with this equipment.
- PV modules shall have an IEC 61730 class A rating.
- Never touch either the positive or negative pole of PV connecting device.
- Strictly prohibit touching both of them at the same time.
- The unit contains capacitors that remain charged to a potentially lethal voltage after the MAINS and PV supply has been disconnected.
- Hazardous voltage will present for up to 5 minutes after disconnection from power supply.
- CAUTION-RISK of electric shock from energy stored in capacitor., Never operate on the solar inverter couplers, The MAINS cables, PV cables or the PV generator when power is applied. After switching off the PV and Mains, always wait for 5minutes to let the intermediate circuit capacitors discharge before you unplug DC and MAINS couplers.
- When accessing the internal circuit of solar inverter, it is very important to wait 45minutes before operating the power circuit or demounting the electrolyte capacitors inside the device. Do not open the device before hand since the capacitors require time to sufficiently discharge!
- Measure the voltage between terminals UDC+ and UDC- with a multi-meter (impedance at least 1Mohm) to ensure that the device is discharged before beginning work (35VDC) inside the device.

2.3 PE Connection and Leakage Current

- The end-use application shall monitor the protective conductor by residual current operated protective device (RCD) with rated fault current $I_{fn} \leq 240\text{mA}$ which automatically disconnects the device in case of a fault.
- DC differential currents are created (caused by insulation resistance and through capacities of the PV generator). In order to prevent unwanted triggering during operation, the rated residual current of the RCD has to be min 240mA.

The device is intended to connect to a PV generator with a capacitance limit of approx 700nf.

	<p>WARNING ! High leakage current! Earth connection essential before connecting supply.</p>
---	--

- Incorrect grounding can cause physical injury, death or equipment malfunction and increase electromagnetic.
- Make sure that grounding conductor is adequately sized as required by safety regulations.
- Do not connect the ground terminals of the unit in series in case of a multiple installation. This product can cause current with a d.c component, Where a residual current operated protective (RCD) or monitoring (RCM) device is used for protection in case of direct or indirect contact, only an RCD or RCM of type B is allowed on the supply side of this product.

➤ **For United Kindom:**

- The installation that connects the equipment to the supply terminals shall comply with the requirements of BS 7671.
- Electrical installation of PV system shall comply with requirements of BS 7671 and IEC 60364-7-712.
- No protection settings can be altered.
- User shall ensure that the equipment is so installed, designed and operated to maintain at all times compliance with the requirements of ESQCR22(1)(a).

➤ **For Australia and New Zealand:**

Electrical installation and maintenance shall be conducted by licensed electrician and shall comply with Australia National Wiring Rules.











• **Island detection method**

The island detection method for X1 series inverter is Active Frequency Drift (AFD).

2.4 Explanation of Symbols

This section gives an explanation of all the symbols shown on the inverter and on the type label.

• **Symbols on the Type Label**

Symbol	Explanation
	CE mark. The inverter complies with the requirements of the applicable CE guidelines.
	TUV certified.
	RCM remark.
	SAA certification.
	Beware of hot surface. The inverter can become hot during operation. Avoid contact during operation.
	Danger of high voltages. Danger to life due to high voltages in the inverter!
	Danger. Risk of electric shock!
	Observe enclosed documentation.
	The inverter can not be disposed together with the household waste. Disposal information can be found in the enclosed documentation.
	Do not operate this inverter until it is isolated from battery, mains and on-site PV generation suppliers.
	Danger to life due to high voltage. There is residual voltage in the inverter which needs 5 min to discharge. • Wait 5 min before you open the upper lid or the DC lid.

3. Introduction

3.1 Basic features

Congratulations on your purchase of a X1 Series inverter from SolaxPower company.

The X1 Series inverter is one of the finest inverter on the market nowadays, incorporating state-of-the-art technology, cost-effective, high reliability.

- Optimal MPPT technology.
- Advanced anti-islanding solutions.
- Excellent protections.
- IP 65 protection level.
- Efficiency up to 97%.
- THD < 2%.
- Current (inrush) < 60A.
- Safe & Reliable: transformer-less design with software and hardware protection. Friendly HMI.
 - LED status indicator.
 - RS 485 communication interface.
 - PC remote control.
 - Update system by USB.
 - Plug and Play Pocket WiFi.

3.2 Terminals of PV Inverter

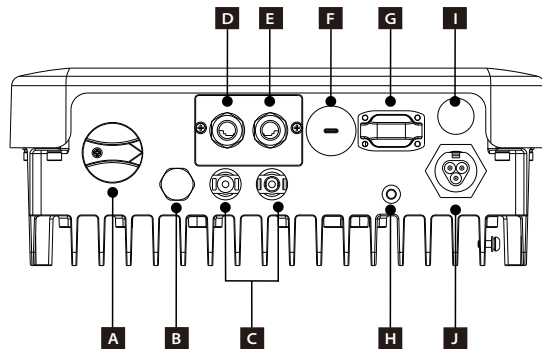

Object	Description
A	DC Switch (opt)
B	Waterproof Lock Valve
C	DC Connector
D	RS 485
E	DRM
F	USB for Update
G	Pocket WiFi (optional)
H	Ground Screw
I	E. F. Alarm (optional)
J	AC Connector



Warning!

Only authorized personnel is allowed to set the connection.

3.3 Dimension and Weight

➢ Dimension

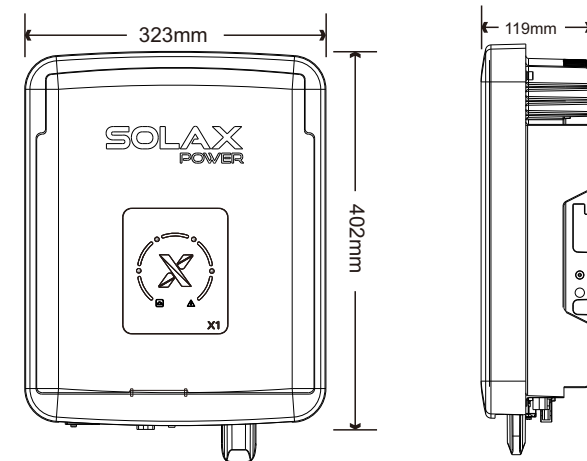

➢ Weight

Model	X1-2.5-S-D X1-2.5-S-N	X1-3.0-S-D X1-3.0-S-N	X1-3.3-S-D X1-3.3-S-N
Net Weight	9.5KG	9.5KG	9.5KG
Gross Weight	11KG	11KG	11KG

4. Technical Data

4.1 DC Input

Model	X1-2.5-S-D X1-2.5-S-N	X1-3.0-S-D X1-3.0-S-N	X1-3.3-S-D X1-3.3-S-N
Max.PV Input Power	2700W	3200W	3450W
Max.PV Voltage	600V	600V	600V
Nominal Voltage	360V		
MPPT Voltage Range	100~580V	100~580V	100~580V
Max.PV Current	10A	10A	10A
ISC PV	12A	12A	12A
MPPT Tracking No.	1		
No. of PV Input	1		

4.2 AC Output

Model	X1-2.5-S-D X1-2.5-S-N	X1-3.0-S-D X1-3.0-S-N	X1-3.3-S-D X1-3.3-S-N
Rated Output Power	2500VA	3000VA	3300VA
Max.Output Power	2500VA	3000VA	3300VA
On-grid Connection	Single-Phase		
Voltage Range	180-280V		
Nominal Voltage	220/230/240V		
Max.Output Current	12A	14A	15A
Maximum Output fault current	14A	16A	17A
Frequency Range	44-55/55-65 Hz		
Nominal Frequency	50/60Hz		
Power Factor	0.8leading~0.8lagging		
THD	< 1%		

4.3 Efficiency, Safety and Protection

Model	X1-2.5-S-D X1-2.5-S-N	X1-3.0-S-D X1-3.0-S-N	X1-3.3-S-D X1-3.3-S-N
Euro - Efficiency	96.50%	96.50%	96.50%
Max.Efficiency	97.60%	97.60%	97.60%
MPPT Efficiency	99.9%	99.9%	99.9%
Safety & Protection			
Over Voltage Protection	YES		
Over Current Protection	YES		
DC isolation Impedance Monitoring	YES		
Ground Fault Current Monitoring	YES		
DC injection Monitoring	YES		
Protective Class	Class I		

4.4 General Data

Model	X1-2.5-S-D X1-2.5-S-N	X1-3.0-S-D X1-3.0-S-N	X1-3.3-S-D X1-3.3-S-N
Net Dimension(W/H/D)	323*402*119mm		
Net Weight	9.5kg		
Installation	Wall-mounted		
Operating Temperature Range	-20°C~ +60°C(derating at 45°C)		
Storage Temperature	-20°C~ +60°C		
Storage/Operation Relative Humidity	0%~95%, no condensation		
Altitude	<2000m		
Protection Level	IP 65(for outdoor use)		
Isolation Type	Transformerless		
Night-time Consumption	0W		
Operating Loss	<5W		
Cooling	Natural Cooling		
Noise Level	<30dB		
Communication Interface	RS485/WiFi(optional)/USB/DRM		
Standard Warranty	5years (10 years optional)		
Pollution degree	II		
Over voltage range(PV/AC)	II / III		

5. Installation

5.1 Check for Transport Damage

Make sure the inverter is intact during transportation. If there are some visible damages, such as cracks, please contact your dealer immediately.

5.2 Packing List

Open the package and fetch out the product, check the accessories at first. The packing list shows as below.

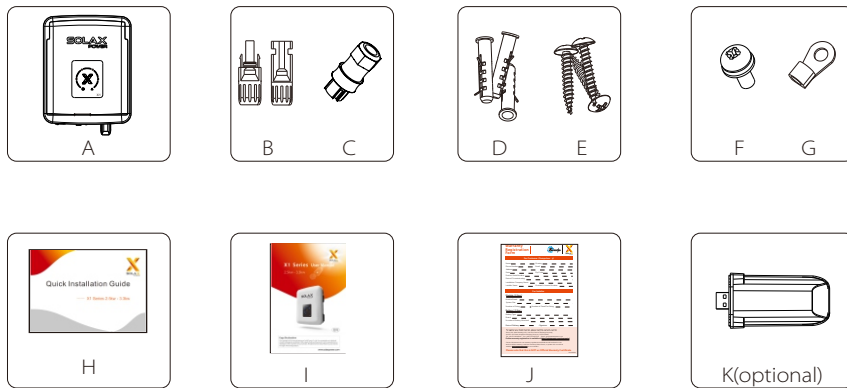

Object	Quantity	Description
A	1	X1 series inverter
B	2	DC connector
C	1	AC connector
D	3	Expansion tube
E	3	Expansion screw
F	1	Cross recessed screw
G	1	Ring terminal X1
H	1	Quick installation guide X1
I	1	Product manual
J	1	Warranty card
K		Plug and Play Pocket WiFi (optional)

5.3 Installation Precaution

X1 Series inverter is designed for outdoor installation (IP 65). Make sure the installation site meets the following conditions:

- Not in direct sunlight.
- Not in areas where highly flammable materials are stored.
- Not in potential explosive areas.
- Not in the cool air directly.
- Not near the television antenna or antenna cable.
- Not higher than altitude of about 2000m above sea level.
- Not in environment of precipitation or humidity (>95%).
- Be sure the ventilation is good enough.
- The ambient temperature in the range of -20°C to +60°C.
- The slope of the wall should be within $\pm 5^\circ$.

Please avoid direct sunlight, rain exposure, snow laying up during installing and operating.

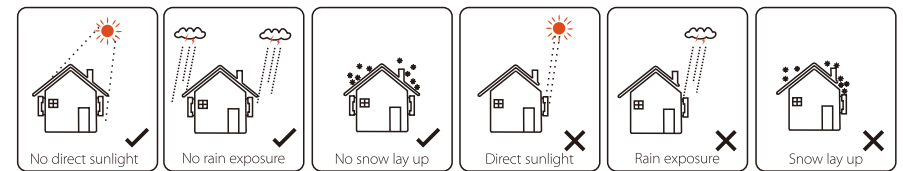

➤ Available Space Size

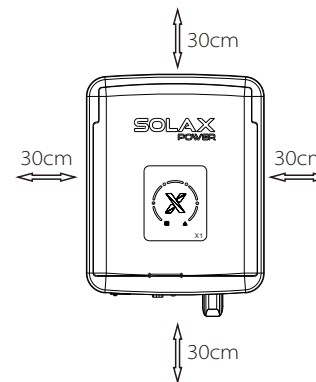

Table Available Space Size

Position	Min.size
Left	30cm
Right	30cm
Top	30cm
Bottom	30cm
Front	30cm

5.4 Installation Steps

➤ Preparation

Below tools are needed before installation.



Installation tools : crimping pliers for binding post and RJ 45, screwdriver, manual wrench and $\varnothing 6$ drill.

➤ Step 1: Screw the wall bracket on the wall

- Use the wall bracket as a template to mark the position of the 3 holes on the wall.
- Drill holes with driller, make sure the holes are deep enough (at least 50mm) for installing and tight the expansion tubes.
- Install the expansion tubes in the holes, and tight them. Then install the wall bracket using the expansion screws.

➤ Step 2: Match the inverter with wall bracket

- Hang the inverter over the bracket, move the inverter close to it, slightly lay down the inverter, make sure the 3 mounting bars on the back are fixed well with the 3 grooves on the bracket.

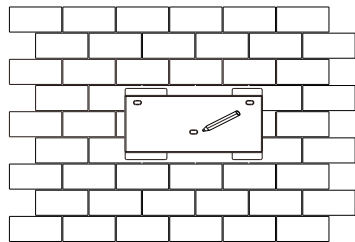

a)

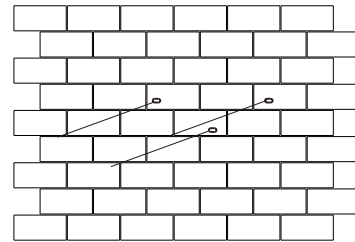

b)

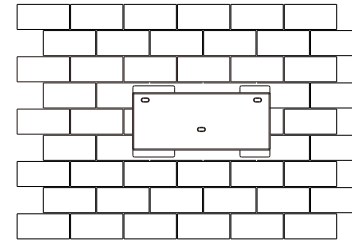

c)

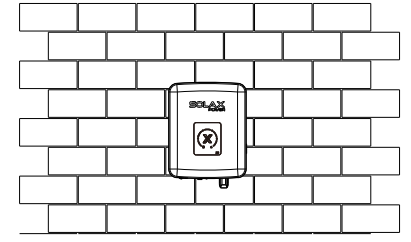

d)

5.5 Connection of the Inverter

5.5.1 The Main Steps to Connect to the Inverter

➤ PV String Connection

X1 series inverter have a couple of PV connector which can be connected to one-string PV modules. Please select PV modules with excellent function and reliable quality. Open circuit voltage of module array connected should be $< \text{Max.DC}$ (table as follow) input voltage : operating voltage should be within the MPPT voltage range.

Table 3 Max. DC Voltage Limitation

Model	X1-2.5-S-D X1-2.5-S-N	X1-3.0-S-D X1-3.0-S-N	X1-3.3-S-D X1-3.3-S-N
Max.DC Voltage	600V	600V	600V



Warning!

PV module voltage is very high which belongs to dangerous voltage range, please comply with the electric safety rules when connecting.



Warning!

Please do not make PV positive or negative ground!



Note!

Please follow the requirements of PV modules as below:
Same type; Same quantity; Identical alignment; Identical tilt.
In order to save cable and reduce the DC loss, we suggest installing the inverter near PV modules.

● **Connection Steps**

- a) Turn off the DC switch.
- b) Choose 12 AWG wire to connect the PV module.
- c) Trip 6mm of insulation from the wire end.
- d) Separate the DC connector as below.

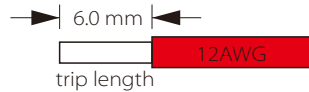

- d) Separate the DC connector as below.

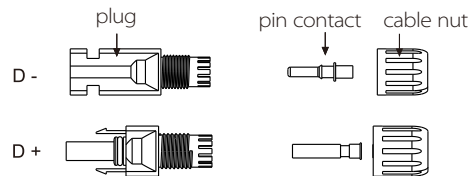

- e) Insert striped cable into pin contact and ensure all conductor strand are captured in the pin contact.
- f) Crimp pin contact by using a crimping pliers. Put the pin contact with striped cable into the corresponding crimping pliers and crimp the contact.

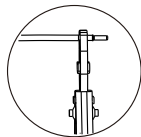

- g) Insert pin contact through the cable nut to assemble into back of the male or female plug. When you feel or heard a “click” the pin contact assembly is seated correctly.

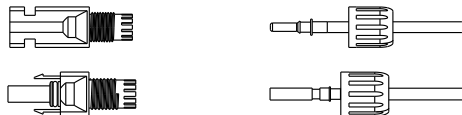

- h) Separate the DC connector
 - Use the specified wrench tool.
 - When separate the DC+ connector, push the tool down from upside.
 - When separate the DC - connector, push the tool down from the bottom.
 - Separate the connectors by hands.

➤ **Grid Connection**

X1 series inverter are designed for single phase grid. Voltage range is 220/230/240V, frequency is 50/60Hz. Other technical requests should comply with the requirement of the local public grid.

Table 4 Cable and Micro-breaker recommended

Model	X1-2.5-S-D X1-2.5-S-N	X1-3.0-S-D X1-3.0-S-N	X1-3.3-S-D X1-3.3-S-N
Cable	4mm ²	4mm ²	4mm ²
Micro-Breaker	20A	20A	20A

Micro-breaker should be installed between inverter and grid, any load should not be connected with inverter directly.

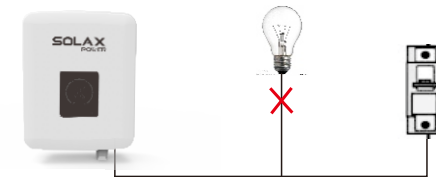

Incorrect Connection between Load and Inverter

● **Connection Steps**

- a) Check the grid voltage and compare with the permissive voltage range (refer to technical data).
- b) Disconnect the circuit-breaker from all the phases and secure against re-connection.
- c) Trip the wires:
 - Trip all the wires to 52.5mm and the PE wire to 55mm.
 - Use the crimping pliers to trip 12mm of insulation from all wire ends as below.

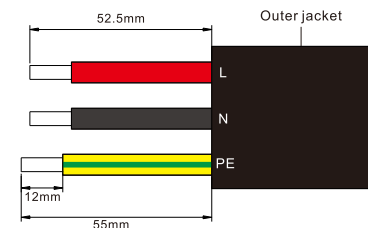

- d) Separate the AC plug into three parts as below.
 - Hold the middle part of the female insert, rotate the back shell to loose it, and detach it from female insert.
 - Remove the cable nut (with rubber insert) from the back shell.
- e) Slide the cable nut and then back shell onto the cable.



- f) Insert the tripped end of each three wires into the appropriate hole in the female insert, and then tight each screw (to tight each wire in place).

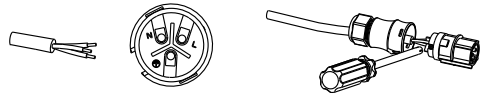

- g) Screw down the threaded sleeve the pressure screw.

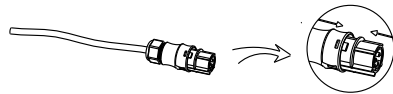

- h) Screw down the pressure screw.
 i) Connect the AC plug to the inverter.

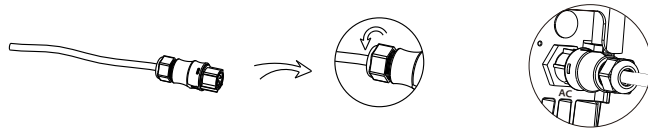

➤ Ground Connection

Screw the ground screw with allen wrench shown as follow.

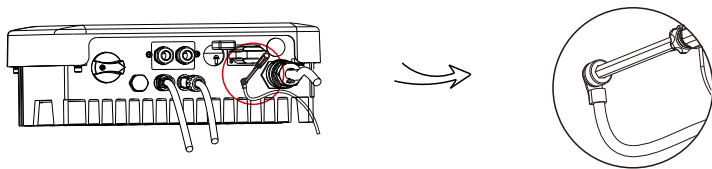

➤ WiFi Connection (optional)

You can read the real time data on the internet either from PC or smartphone with WiFi monitoring.

● Connection Step:

- a) Open the WiFi lid on the back of the inverter.
 b) Plug the Pocket WiFi (from Solax) into the port named "WiFi" on inverter, and tighten the four screws as below.
 c) Connect the WiFi with the router. (Please refer to "WiFi Setting Guide")
 d) Set the station account on the Solax web. (Please refer to "WiFi Setting Guide")

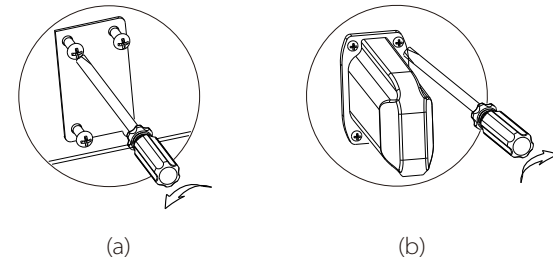

5.5.2 Communication Interface

This product has a series communication interfaces : RS 485, USB, DRM.
 Operating information like output voltage, current, frequency, fault information, etc., can be delivered to PC or other monitoring equipment via these interfaces.

➤ RS 485 Communication

When user wants the information of the power station and manage the entire power system. We offer RS 485 communication.

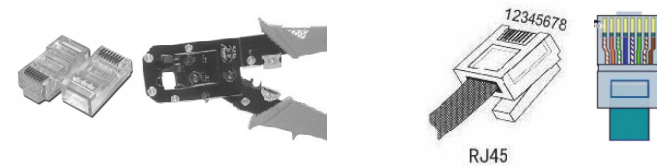

• **Communication**

RS 485 is generally for inverter's communication. System monitor should be configured to realize one PC communicates with inverter at same time. Through PC could get real time PV plants operating data. The correspond relationship of the pins of RJ 45 and network cable color shows as below.

T568B connection order

RJ 45 Line NO.	Cable Color
1	Whight orange
2	Orange
3	White green
4	Blue
5	White blue
6	Green
7	White brown
8	Brown

• **Connection steps**

Cable Color	RS 485 Converter
4 Blue	A
5 White blue	B

RS 485 converter connection

Choose high-quality network cable, trip the insulation from the wire ends. For the end use for the inverter, follow T568B order with press pliers to push into the 8-wire RJ 45 crystal head. For the other end, follow the 2-wire RJ 45 crystal head to connect with the RS 485 converter connector.

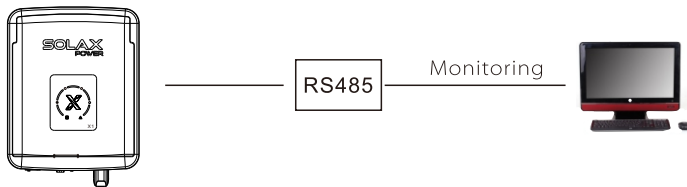

➤ **USB for Updating**

User can update the inverter system through a USB flash drive.



Warning!

Make sure the input voltage is more than 100V (in good illumination condition). Or it may result in failing during updating.

• **Connection steps**

a) Prepare a USB flash drive. Download the latest installation package named "update.rar" from Solax website: www.solaxpower.com. And then extract it into following directory:

```
"update\ARM\618.00076.00_X1AIR_ARM_Vx.xx_XXXXXXX.usb";
"update\DSP\618.00070.00_X1AIR_DSP_Vx.xx_XXXXXXX.hex".
```



Warning!

Make sure the directory is in accordance with above form strictly! Do not modify the program file name and the capital letter can not be changed to lower case! Or it may cause the inverter doesn't work anymore!

b) Make sure the DC switch is off and disconnect the AC with grid. Insert USB flash drive into the "USB" port on the bottom of the inverter. Then turn on DC switch or connect the PV connector, blue light "a" and red light "b" flash alternately for 10 times. Indicator light "1", "2", "3", "4" are unlit.

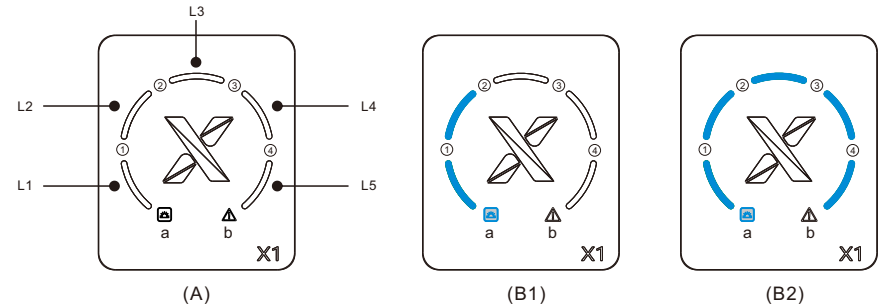

Warning!

During updating, don't switch off the DC switch or cut off the external dc breaker!

c) About 10 seconds later, the system will be updated automatically. During this period, blue light "a" is always been on and red light "b" is unlit. Indicator light "L1", "L2", "L3", "L4", "L5" show the progress of system updating. Refer to figure (B1), it shows that the updating process is half-finished. Once finished completely, it shows as figure (B2).

The updating process for ARM needs about 5 seconds and DSP needs about 3 minutes.



Note !

If the updating process is paused for more than 3 minutes, please reinsert the USB flash drive.

➤ **DRM**

DRM means demand response mode.

• **Communication**

DRM is provided to give remote control with the optional accessory. The remote control function provides a contact signal to operate the inverter. The pin definition and the circuit connection show as below.

Pin	1	2	3	4	5	6	7	8
Definition	DRM1	DRM2	DRM3	DRM4	3.3V	DRM0	GND	GND

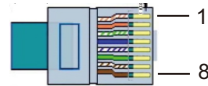

• **Connection steps**

- Choose at least 1mm² wire. Trip the insulation from the wire ends.
- Open the lid on the bottom of the inverter.
- Insert the tripped wire into the hole of the terminal block.
- Screw down the screws on the terminal block.

➤ **E.F.Alarm (optional)**

E.F.Alarm means Earth Fault Alarm. It is the additional detection for functionally earthed PV arrays, as required by AS 4777.2 and AS/NZS 5033.

- Measure the resistance to earth of each conductor of the PV array.
- If the earth resistance is above the resistance limit(R_{so} limit) threshold 30K Ω , the system shall reconnect the functional earth and shall be allowed to start.
- If the earth resistance is equal to or less than the resistance limit(R_{so} limit) threshold 30K Ω , the inverter shall shut down and initiate an earth fault alarm in accordance with the requirements of IEC 62109-2.



Note !

Direct functional earthing of system is not recommended. Functional earthing via a resistor is a safer option.

5.6 Start the Inverter

5.6.1 Start the inverter after checking all below steps:

- Make sure all the DC breaker and AC breaker are disconnected.
- AC cable is connected to grid correctly.
- All PV panels are connected to inverter correctly, DC connectors which are not used should be sealed by cover.

5.6.2 Start inverter

- Turn on switches of DC and AC side.
- Inverter will start up automatically when PV panels generate enough energy. Below is three different states when operating, which means inverter starting up successfully.

- **Waiting:** Inverter is waiting to checking when output DC voltage from PV panels is greater than 65V (lowest start-up voltage) but less than 100V (lowest operating voltage). Under this mode, the blue light "a" is flickering, shown as figure (A).

- **Checking:** Inverter will check output environment automatically when DC output voltage of PV panels. Under this mode, the blue light "a" is flickering, shown as figure (A).

- **Normal:** Inverter begins to operate normally with blue light "a" on. Inverter will work in MPPT mode when PV voltage is in the MPPT voltage range, inverter will stop feedback to grid when PV power is not enough. Under this mode, the blue light "a" is always on, light "L1,L2,L3,L4,L5" represent the output power. As shown in figure (B), the output power is 0%~20%".

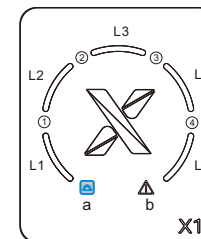

(A)
waiting/checking

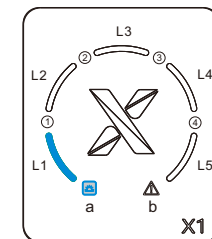

(B)
Normal

6. Operation

6.1 Indicator Pannel

Make sure the inverter is intact during transportation. If there are some visible damages, such as cracks, please contact your dealer immediately.

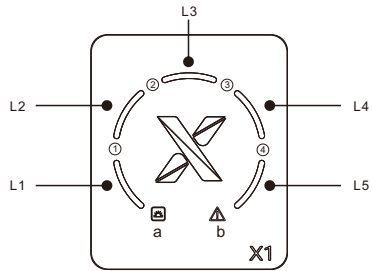

Indicator light	Color	Description
a	blue	working properly
b	red	fault
1/2/3/4	red	fault types
L1/L2/L3/L4/L5	blue	output power

6.2 Indicator Information

➤ Normal working







Blue light "a" keeps on. Light "a,b,c,d" are unlit:

Indicator	Description
	Output power range : 0% ~ 20%
	Output power range : 20% ~ 40%
	Output power range : 40% ~ 60%
	Output power range : 60% ~ 80%
	Output power range : 80% ~ 100%

➤ Working fault

Red light "b" keeps on, light "L1, L2, L3, L4, L5" are unlit :

Indicator	Fault	Description
	PV Volt Fault	PV Over Voltage Fault
	Isolation Fault	Isolation Fault
	Temp Over Fault	Over Temperature Fault
	DCI Fault	DCI Device Fault DCI OCP Fault
	RCD Fault	RCD Fault
	Mains Lost	Grid Lost Fault
	Grid Volt Fault	Grid Volt Fault
	Grid Freq Fault	Grid Freq Fault
	Consistant Fault	Sample Fault

Indicator	Fault	Description
	Relay Fault	Relay Fault
	EEPROM Fault	Inv EEprom Error Mgr Eeprom Fault
	Comms Lost	Include SPI,SCI Faults
	Bus High	Bus Volt Fault
	TZ Fault	Tz Protect Fault SW OCP Fault
	Other Device Fault	Other Device Fault PLL Lost Fault

7. Troubleshooting

7.1 Troubleshooting

This section contains information and procedures for solving possible problems with the X1 series inverter, and provides some troubleshooting tips to identify and solve most problems that could occur with X1 series inverter. This section will help you narrow down the source of any problems you may encounter. Please read the following troubleshooting steps.

Check the indicator light state. Record it before anything further solutions. Attempt the solution indicated in troubleshooting list. If the indicator lamp unlit, check the following list to make sure that the present state of the installation allows proper operation.

- Is the inverter located in a clean, dry, adequately ventilated place?
- Have the DC input breakers been opened?
- Are the cables adequately sized and short enough?
- Are the communication cable properly connected and undamaged?

Please contact SolaX Power company customer service for further assistance. Please be prepared to describe details of your system installation and provide the model and serial number of the unit.

Troubleshooting List

Fault	Description
PV Volt Fault	- Check the panel's open circuit voltage whether the value is similar or already $>$ Max. DC voltage. - Please seek help from us when voltage \leq Max. DC voltage.
Isolation Fault	- Check the connection of the inverter. - Or seek help from us.
Temp Over Fault	- Check the connection of the inverter. - Or seek help from us.
DCI Fault	- Check the connection of the inverter. - Or seek help from us.

Fault	Description
RCD Fault	Leakage current detection circuit Fault. - Disconnect PV+, PV-, reconnect them. - Or seek help from us, if can not go back to normal state.
Mains Lost	Off to grid. - Please check grid-connection, like wire, interface, etc, - Checking grid usability. - Or seek help from us.
Grid Volt Fault	Grid voltage out of range. - System will reconnect if the utility is back to normal. - Or seek help from us.
Grid Freq Fault	Grid frequency out of range. - System will reconnect if the utility is back to normal. - Or seek help from us.
Consistant Fault	- Disconnect PV+, PV_, reconnect them. - Or seek help from us, if can not go back to normal state.
Relay Fault	Relay is failure between grid and inverters. - Disconnect PV+, PV-, reconnect them. - Or seek help from us, if can not go back to normal state.
EEPROM Fault	Eeprom Fault. - Disconnect PV+, PV-, reconnect them. - Or seek help from us, if can not go back to normal state.
Comms Lost	- Disconnect PV+, PV-, reconnect them. - Or seek help from us, if can not go back to normal state.
Bus High	Bus voltage out of normal range. - Disconnect PV+, PV-, reconnect them. - Check if the PV input is within the range of the inverter. - Or seek help from us, if can not go back to normal state.
TZ Fault	- Disconnect PV+, PV-, reconnect them. - Or seek help from us, if can not go back to normal state.
Other Device Fault	Else. - Seek help from us.

7.2 Maintenance

Inverters do not need to maintenance or correction in most condition, but if the inverter often loses power due to overheating, this can be the following reason:

- The cooling fins on the rear of house are covered with dirt.
- Clean the cooling fins with a soft dry cloth or brush if necessary.



Warning!

Only trained and authorized professional personnel who are familiar with the requirements of safety are allowed to perform servicing and maintenance work.

➤ Safety Checks

Safety checks should be performed at least every 12 months by manufactures' qualified person who has adequate training, knowledge, and practical experience to perform these tests. The data should be recorded in an equipment log. If the device is not functioning properly or fails any of test, the device has to be repaired.

➤ Maintain periodically

Only qualified person may perform the following works. During the process of using the inverter, the manage person shall examine and maintain the machine regularly. The concrete operations are follow.

1. Check that if the cooling fins on the rear of house are covered by dirt, and the machine should be cleaned and absorbed dust when necessary. This work shall be check time to time.
2. Check that if the input and output wires are damaged or aged. This check should be performed at least every 6 months.
3. The inverter panels should be cleaned and security checked every 6 months at least.

8. Decommissioning

8.1 Decommissioning

Disconnect the inverter from DC input and AC output.
Remove all connection cables from the inverter.
Remove the inverter from the bracket.

If possible, please pack the inverter with the original packaging.
If it is no longer available, you can also use an equivalent carton that meets the following requirements.

Suitable for loads more than 30kg.
With handle.
Can be fully closed.

8.2 Storage and Transportation

Store the inverter in dry place where ambient temperature are always between $-20^{\circ}\text{C} \sim +60^{\circ}\text{C}$. Take care of the inverter during the storage and transportation, keep less than 4 cartoons in one stack.

8.3 Disposal

Please be sure to deliver wasted inverter and packing materials to certain site, where can assist relevant department to dispose to and recycle.